

intercable

Datasheet Kabelschoen 35mm² M16

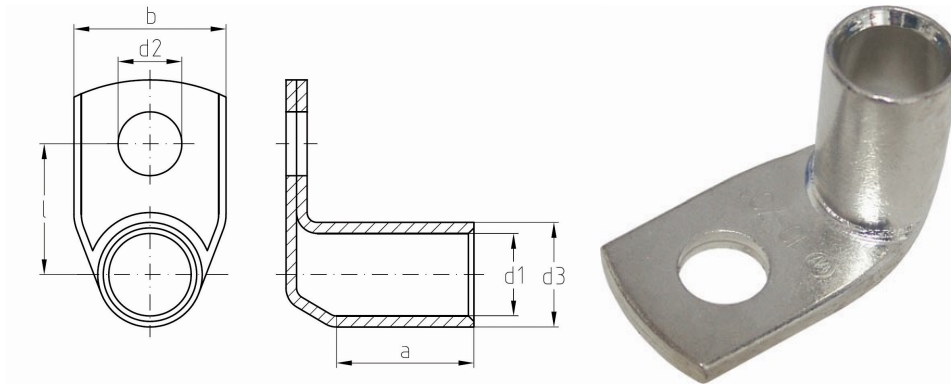

Artikelnummer	ICF351690
Doorsnede Kabel	35 mm ²
Gatmaat	M16
Materiaal	CU-HCP 99,95% vlgns DIN EN 13600
Afwerking	Galvanisch vertind

Maten:

D1	9,20 mm
D3	12,40 mm
D2	17,00 mm
B	28,00 mm
L	24,70 mm
A	17,00 mm
Gewicht	2,25 kg/100